

AIR CONDITIONER
REMOTE CONTROLLER ILLUSTRATION

The design and specifications are subject to change without prior notice for product improvement. Consult with the sales agency or manufacturer for details.

CR193-RG70E2(2)BGEU1
16117000001054
20171013

Thank you very much for purchasing our air conditioner. Please read this owner's manual carefully before using your air conditioner. Make sure to save this manual for future reference.

CONTENTS

Remote controller Specifications.....	1
Operation of buttons	2
Indicators on LCD	6
How to use the buttons	7
AUTO/COOL operation.....	7
DRY/FAN operation.....	8
HEAT operation	9
Setting the Timer function	9
Handling the remote controller	13

Remote Controller Specifications

Model	RG70E2(2)/BGEFU1, RG70E3(2)/BGEF, RG70E2(2)/BGEF
Rated Voltage	3.0V(Dry batteries R03/LR03×2)
Signal Receiving Range	8m
Environment	-5°C~60°C(23°F~140°F)

Operation of buttons

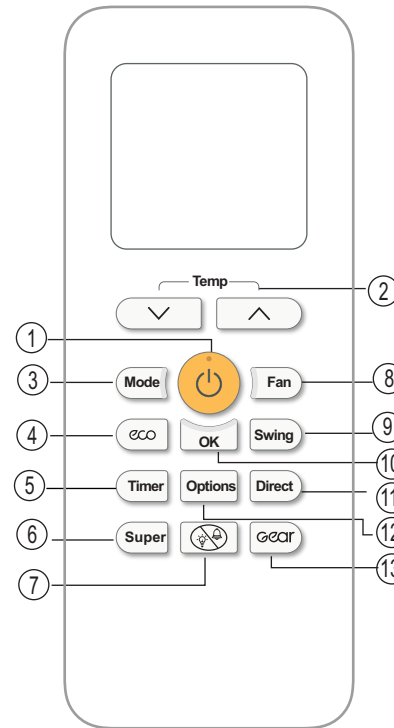

Model: RG70E2(2)/BGEFU1
RG70E2(2)/BGEF

- 1 ON/OFF Button()**
Turns the air conditioner ON and OFF.
- 2 Temp Up Button()**
Increases temperature in 1°C(1°F) increments. Max. temperature is 30°C(86°F).

- Temp Down Button()**
Decreases temperature in 1°C(1°F) increments. Min. temperature is 16°C(60°F).

NOTE:

- When the air conditioner operates under heating mode with the set temperature of 16°C(60°F), pressing button twice in one second will activate 8 Degree heating. The indoor unit display shows "FP".
- Press and hold **UP** and **DOWN** buttons together for 3 seconds will alternate the temperature display between the °C & °F scale.

3 Mode Button

Scrolls through operation modes as follows:

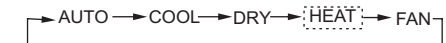

NOTE: Please do not select HEAT mode if the machine you purchased is cooling only type. Heat mode is not supported by the cooling only appliance.

4 ECO Button

- Used to enter the energy efficient mode.
- Under cooling mode, press this button, the air conditioner will automatically operate at 24°C(75°F), with auto fan speed.

NOTE:

- Pressing the ECO button, or modifying the mode or adjusting the set temperature to less than 24°C(75°F) will stop ECO operation.
- The ECO operation will be stopped automatically after 8 hours. Under ECO operation, the set temperature should be 24°C(75°F) or more, it may result in insufficient cooling. If you feel uncomfortable, just press the ECO button again to stop it.

5 Timer Button

Press this button to initiate the auto-on/ auto-off time sequence.

Operation of buttons

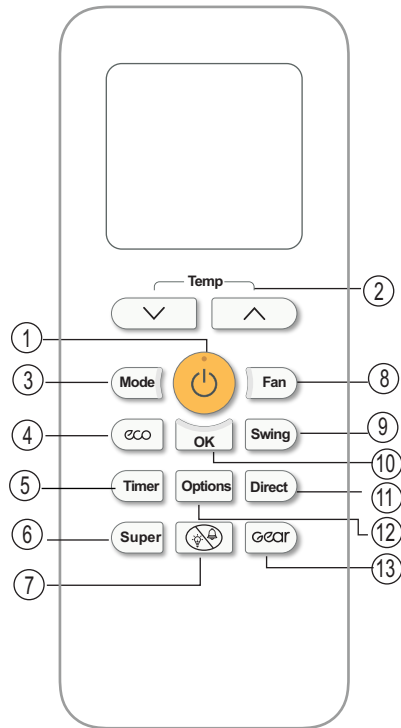

Model: RG70E2(2)/BGEFU1
RG70E2(2)/BGEF

6 Super Button

- Press this button under cooling operation, the set temperature will change to 17°C(62°F), the fan speed shift to high and bring faster cooling operation.
- Press this button under heating operation, the set temperature will change to 30°C(86°F), the fan speed shift to high and bring faster heating operation.

NOTE:

- This function is not available under AUTO, DRY, FAN, Self Clean or Comfort mode.
- Press MODE, FAN, SLEEP or ECO button will cancel Super function.

7 Do Not Disturb Button ()

Press this button to turn off the indoor screen display, and also turn off the Air conditioner buzzer, the fan speed shifts to low, which create a comfortable and quiet environment. Press it again to cancel this function. Under Do Not Disturb mode, the display will illuminate for 10 seconds while adjusting the mode, set temperature or fan speed, etc.

8 Fan Button

Selects fan speeds in the following order:
AU → 20% → 40% → 60% → 80% → F%.

Press the Temp ^ or Temp v button to increase/decrease the fan speed in 1% increments.

NOTE:

- You can not switch the fan speed in AUTO or DRY mode.
- Hold down this button for at least 2 seconds to activate/cancel **Silent** mode. Due to low frequency operation of compressor, it may result in insufficient cooling and heating capacity (applicable to the air conditioner with Silent feature only)
- Press Fan, MODE, Sleep, ON/OFF, ECO or Gear button will cancel the Silent function.

9 Swing Button (for RG70E(2) series only)

Used to stop or start horizontal louver movement. The louver will swing up and down automatically.

Operation of buttons

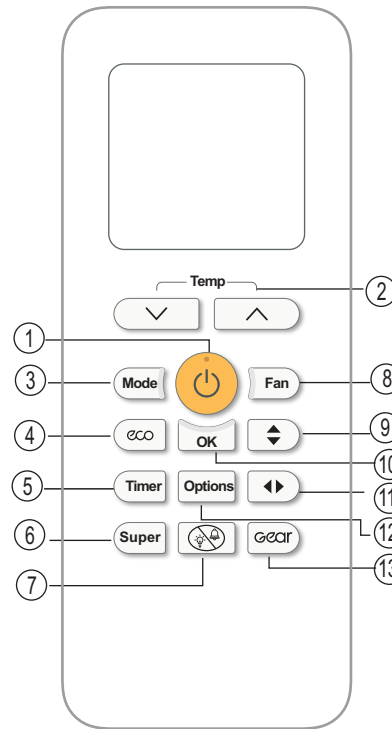

Model: RG70E3(2)/BGEF

Swing Button (for RG70E3(2)/BGEF only)

Used to stop or start horizontal louver movement or set the desired up/down air flow direction. The louver changes 6 degree in angle for each press. If keep pushing more than 2 seconds, the louver will swing up and down automatically.

10 OK Button

Used to confirm the optional functions.

11 Direct Button (for RG70E(2) series only)

Used to set the desired air flow direction. The louver changes 6 degree in angle for each press.

Swing Button (for RG70E3(2)/BGEF only)

Used to stop or start vertical louver movement and set the desired left/right air flow direction. The louver changes 6 degree in angle for each press. If keep pushing more than 2 seconds, the louver will swing left and right automatically.

12 Options Button

Press this button to select the air conditioner function in a sequence of following:
Fresh → Follow me → Self clean → Repellent → Sleep

Press the **Options** button to select the desired function, the selected symbol will flash on the display area, then press the **OK** button to confirm.

* FRESH function ()

When the FRESH function is initiated, the Ionizer/Plasma Dust Collector (depending on models) is energized and will help to remove pollen and impurities from the air.

* FOLLOW ME function ()

When the Follow Me function is activated, the remote display is actual temperature at its location. The remote control will send this signal to the air conditioner every 3 minutes interval until press the FOLLOW ME button again.

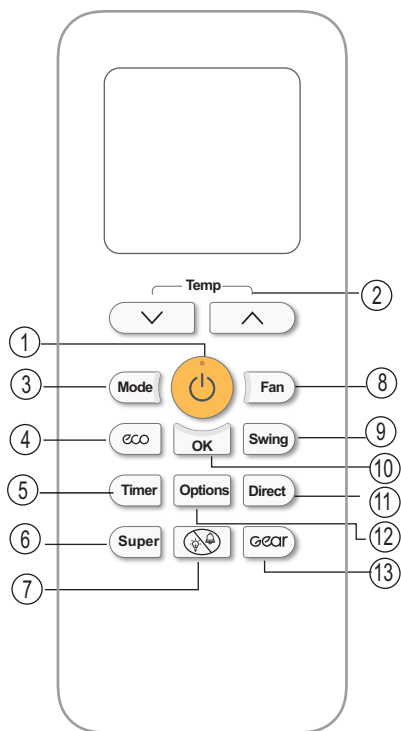

*** SELF CLEAN function** (🌀)

Under SELF CLEAN mode, the air conditioner will automatically clean and dry the Evaporator and keep it as fresh for the next operation. It is not available under heating or fan mode.

*** Repellent function** (🦟)

The mosquito repellent module will be activated which generate some frequency sound to scare off mosquito.

(* Indicate optional functions)

SLEEP function (🌙)

The SLEEP function is used to decrease energy use while you sleep (and don't need the same temperature settings to stay comfortable). This function can only be activated via remote control.

Note: The SLEEP function is not available in FAN or DRY mode.

16 Gear Button

- Press this button to enter the energy efficient mode in a sequence of following:
 - 75% (up to 75% electrical energy consumption)
 - 50% (up to 50% electrical energy consumption)
 - Previous setting mode
- Turn off the unit or activate ECO, sleep, FP, Super, Silent or Self clean function will cancel the electrical energy consumption control function.
- This function is only available under COOL mode.

NOTE:

- Buttons design is based on typical model and might be slightly different from the actual one you purchased. the actual shape shall prevail.
- All the functions described are accomplished by the unit. If the unit has no this feature, there is no corresponding operation happened when press the relative button on the remote controller.
- When there are wide differences between "Remote controller Illustration" and "USER'S MANUAL" on function description, the description of "USER'S MANUAL" shall prevail.

Indicators on LCD

Information are displayed when the remote controller is powered up.

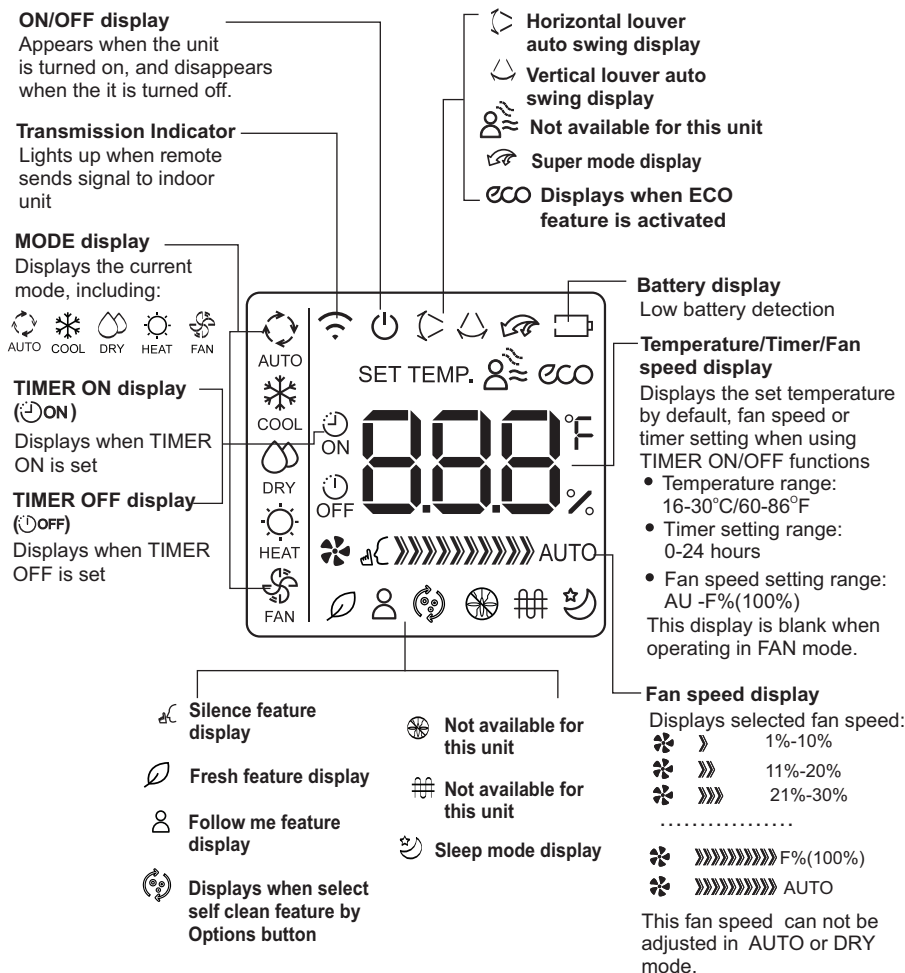

Note:

All indicators shown in the figure are for the purpose of clear presentation. But during the actual operation only the relative functional signs are shown on the display window.

How to use the buttons

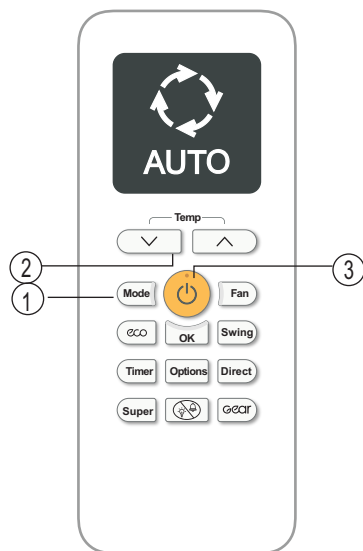

AUTO operation

SETTING TEMPERATURE

The operating temperature range for units is 16-30°C/60-86°F. You can increase or decrease the set temperature in 1°C/1°F increments.

In **AUTO** mode, the unit will automatically select the COOL, FAN, HEAT or DRY mode based on the set temperature.

1. Press the **MODE** button to select Auto mode.
2. Set your desired temperature using the **Temp** ∇ or **Temp** \wedge button.
3. Press the **ON/OFF** button to start the unit.

NOTE: **FAN SPEED** can't be set in Auto mode.

COOL operation

1. Press the **MODE** button to select **COOL** mode.
2. Set your desired temperature using the **Temp** ∇ or **Temp** \wedge button.
3. Press the **FAN** button to select the fan speed in a range of AU-F%, in conjunction with **Temp** \wedge or **Temp** ∇ button.
4. Press the **ON/OFF** button to start the unit.

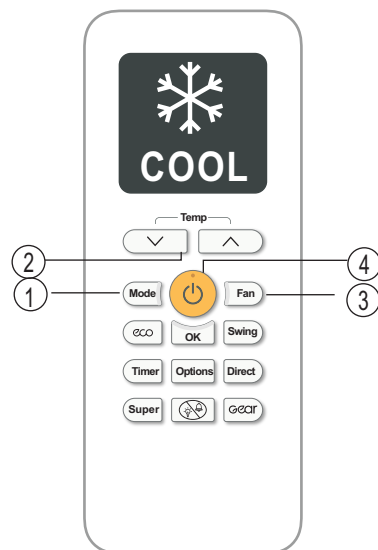

7

How to use the buttons

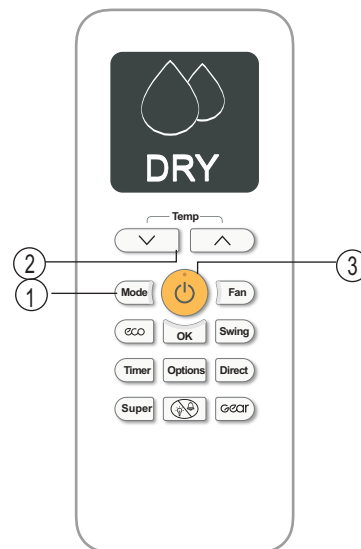

DRY operation(dehumidifying)

1. Press the **MODE** button to select **DRY** mode.
2. Set your desired temperature using the **Temp** ∇ or **Temp** \wedge button.
3. Press the **ON/OFF** button to start the unit.

NOTE: **FAN SPEED** can't be changed in DRY mode.

FAN operation

1. Press the **MODE** button to select FAN mode.
2. Press the **FAN** button to select the fan speed in a range of AU-F%, in conjunction with **Temp** \wedge or **Temp** ∇ button.
3. Press the **ON/OFF** button to start the unit.

NOTE: You can't set temperature in FAN mode. As a result, your remote control's LCD screen will not display temperature.

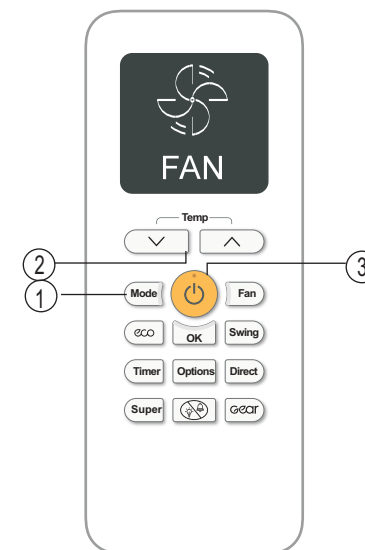

8

How to use the buttons

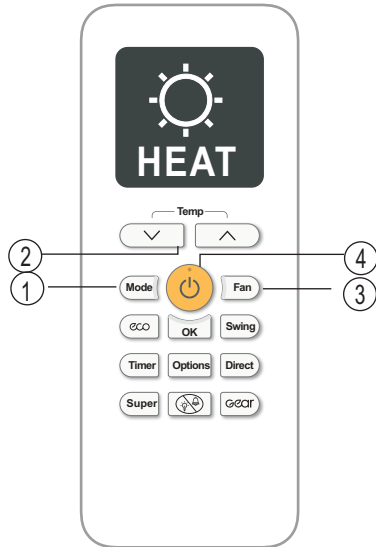

HEAT operation

1. Press the **MODE** button to select **HEAT** mode.
2. Set your desired temperature using the **Temp** \downarrow or **Temp** \uparrow button.
3. Press the **FAN** button to select the fan speed in a range of AU-F%, in conjunction with **Temp** \uparrow or **Temp** \downarrow button.
4. Press the **ON/OFF** button to start the unit.

NOTE: As outdoor temperature drops, the performance of your unit's HEAT function may be affected. In such instances, we recommend using this air conditioner in conjunction with other heating appliance.

Setting the TIMER function

Your air conditioning unit has two timer-related functions:

- **TIMER ON**- sets the amount of timer after which the unit will automatically turn on.
- **TIMER OFF**- sets the amount of time after which the unit will automatically turn off.

TIMER ON function

The **TIMER ON** function allows you to set a period of time after which the unit will automatically turn on, such as when you come home from work.

1. Press the **Timer** button, the Timer on indicator "⌚" displays and flashes. By default, the last time period that you set and an "h" (indicating hours) will appear on the display.

Note: This number indicates the amount of time after the current time that you want the unit to turn on. For example, if you set **TIMER ON** for 2 hours, "2.0h" will appear on the screen, and the unit will turn on after 2 hours.

2. Press the **Temp** \downarrow or \uparrow button to set the time when you want the unit to turn on.
3. Wait 2 seconds, then the **TIMER ON** function will be activated. The digital display on your remote control will then return to the temperature display.

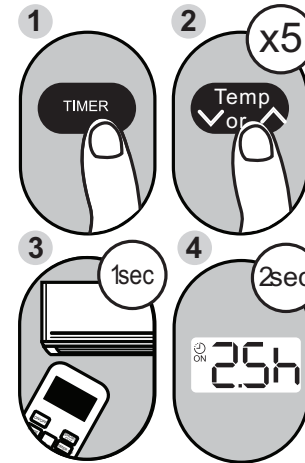

Example: Setting unit to turn on after 2.5 hours.

TIMER OFF function

The **TIMER OFF** function allows you to set a period of time after which the unit will automatically turn off, such as when you wake up.

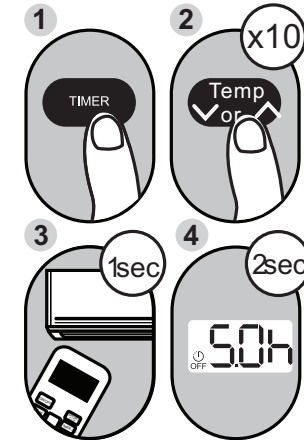

Example: Setting unit to turn off after 5 hours.

NOTE: When setting the **TIMER ON** or **TIMER OFF** functions, up to 10 hours, the time will increase in 30 minute increments with each press. After 10 hours and up to 24, it will increase in 1 hour increments. The timer will revert to zero after 24 hours. You can turn off either function by setting its timer to "0.0h".

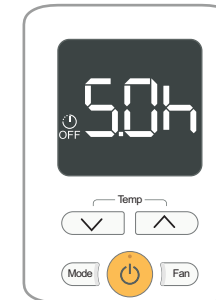

Continue to press **Temp** \downarrow or \uparrow button until desired time is reached.

Setting both TIMER ON and TIMER OFF at the same time

Keep in mind that the time periods you set for both functions refer to hours after the current time. For example, say that the current time is 1:00 PM, and you want the unit to turn on automatically at 7:00 PM. You want it to operate for 2 hours, then automatically turn off at 9:00 PM.

Do the following:

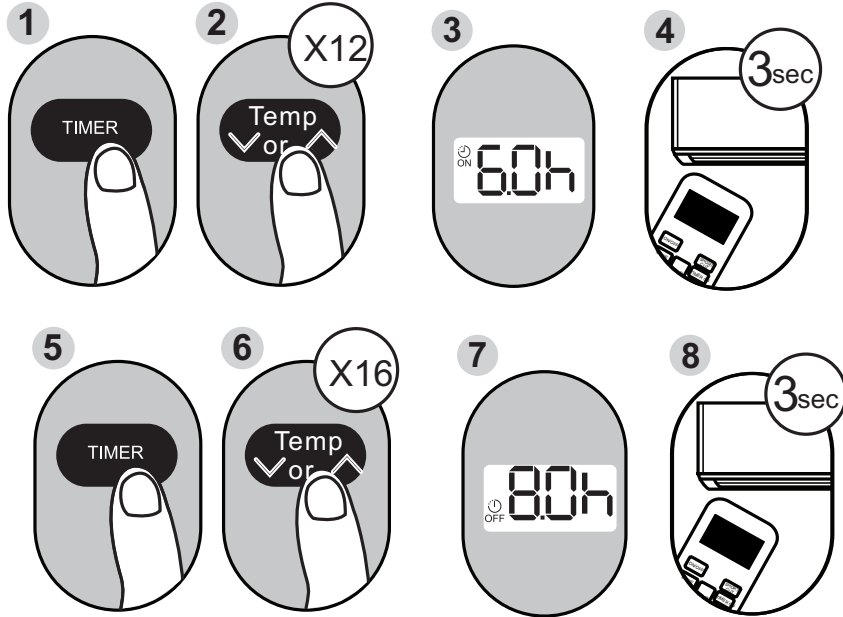

Example: Setting the unit to turn on after 6 hours, operate for 2 hours, then turn off (see the figure below)

Your remote display

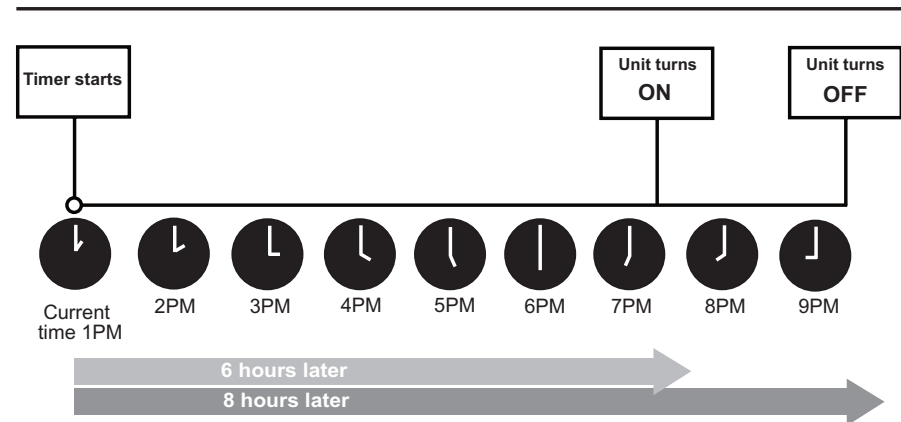
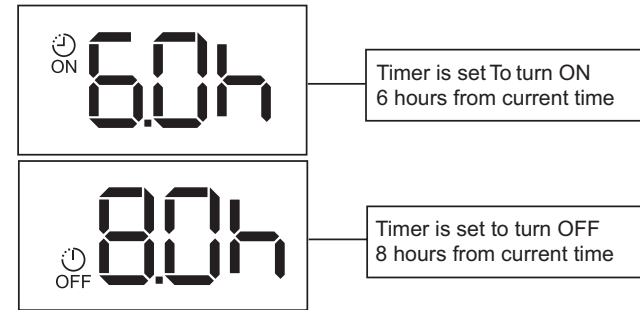

Handling the remote controller

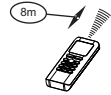
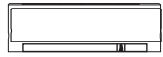

Location of the remote controller.

- Use the remote controller within a distance of 8 meters from the appliance, pointing it towards the receiver. Reception is confirmed by a beep.

CAUTIONS

- The air conditioner will not operate if curtains, doors or other materials block the signals from the remote controller to the indoor unit.
- Prevent any liquid from falling into the remote controller. Do not expose the remote controller to direct sunlight or heat.
- If other electrical appliances react to the remote controller, either move these appliances or consult your local dealer.
- Do not drop the remote controller. Handle with care.
- Do not place heavy objects on the remote controller, or step on it.

NOTE:

The device could comply with the local national regulations.

- In Canada, it should comply with CAN ICES-3(B)/NMB-3(B).
- In USA, this device complies with part 15 of the FCC Rules. Operation is subject to the following two conditions:
 - (1) This device may not cause harmful interference, and
 - (2) this device must accept any interference received, including interference that may cause undesired operation.

This equipment has been tested and found to comply with the limits for a Class B digital device, pursuant to part 15 of the FCC Rules. These limits are designed to provide reasonable protection against harmful interference in a residential installation. This equipment generates, uses and can radiate radio frequency energy and, if not installed and used in accordance with the instructions, may cause harmful interference to radio communications. However, there is no guarantee that interference will not occur in a particular installation. If this equipment does cause harmful interference to radio or television reception, which can be determined by turning the equipment off and on, the user is encouraged to try to correct the interference by one or more of the following measures:

- Reorient or relocate the receiving antenna.
- Increase the separation between the equipment and receiver.
- Connect the equipment into an outlet on a circuit different from that to which the receiver is connected.
- Consult the dealer or an experienced radio/TV technician for help.
- Changes or modifications not approved by the party responsible for compliance could void user's authority to operate the equipment.

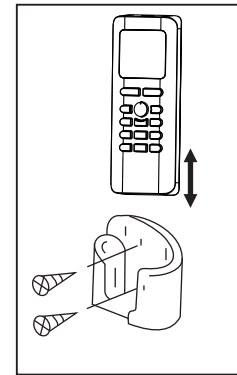

Using the remote controller holder (optional)

- The remote controller can be attached to a wall or pillar by using a remote controller holder (not supplied, purchased separately).
- Before installing the remote controller, check that the air conditioner receives the signals properly.
- Install the remote controller with two screws.
- For installing or removing the remote controller, move it up or down in the holder.

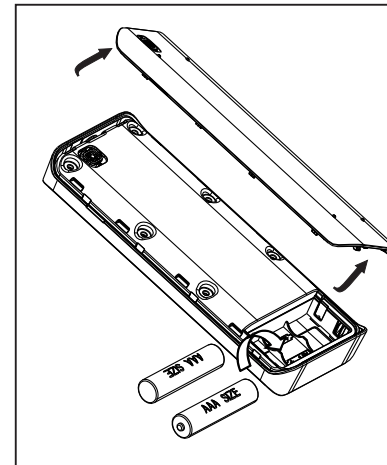

Replacing batteries

The following cases signify exhausted batteries. Replace old batteries with new ones.

- Receiving beep is not emitted when a signal is transmitted.
- Indicator fades away.

The remote controller is powered by two dry batteries (R03/LR03X2) housed in the back rear part and protected by a cover.

- (1) Remove the back cover of the remote controller.
- (2) Remove the old batteries and insert the new batteries, placing the (+) and (-) ends correctly.
- (3) Install the cover back on.

NOTE: When the batteries are removed, the remote controller erases all programming. After inserting new batteries, the remote controller must be reprogrammed.

CAUTIONS

- Do not mix old and new batteries or batteries of different types.
- Do not leave the batteries in the remote controller if they are not going to be used for 2 or 3 months.
- Do not dispose batteries as unsorted municipal waste. Collection of such waste separately for special treatment is necessary.

技术要求：

尺寸：130*185

材质：80克双胶纸
黑白